

CORNELL PUMP COMPANY

# MUNICIPALITIES



EFFICIENT BY DESIGN



# SOLIDS HANDLING



## SOLIDS HANDLING

Cornell Solids Handling pumps are used for waste water, sludge, sewer systems, stringy material, de-watering, abrasive transfer, canneries, construction, dredging, lumber mills, slush ice, reclamation plants and foundry or mill slag.

Available with Delta™, Semi-open, Enclosed, and Chopper impellers, Cornell pumps are offered in various discharge sizes ranging from 3 to 30 inches, with heads to 470 feet TDH, and flow rates of up to 38,000 GPM.

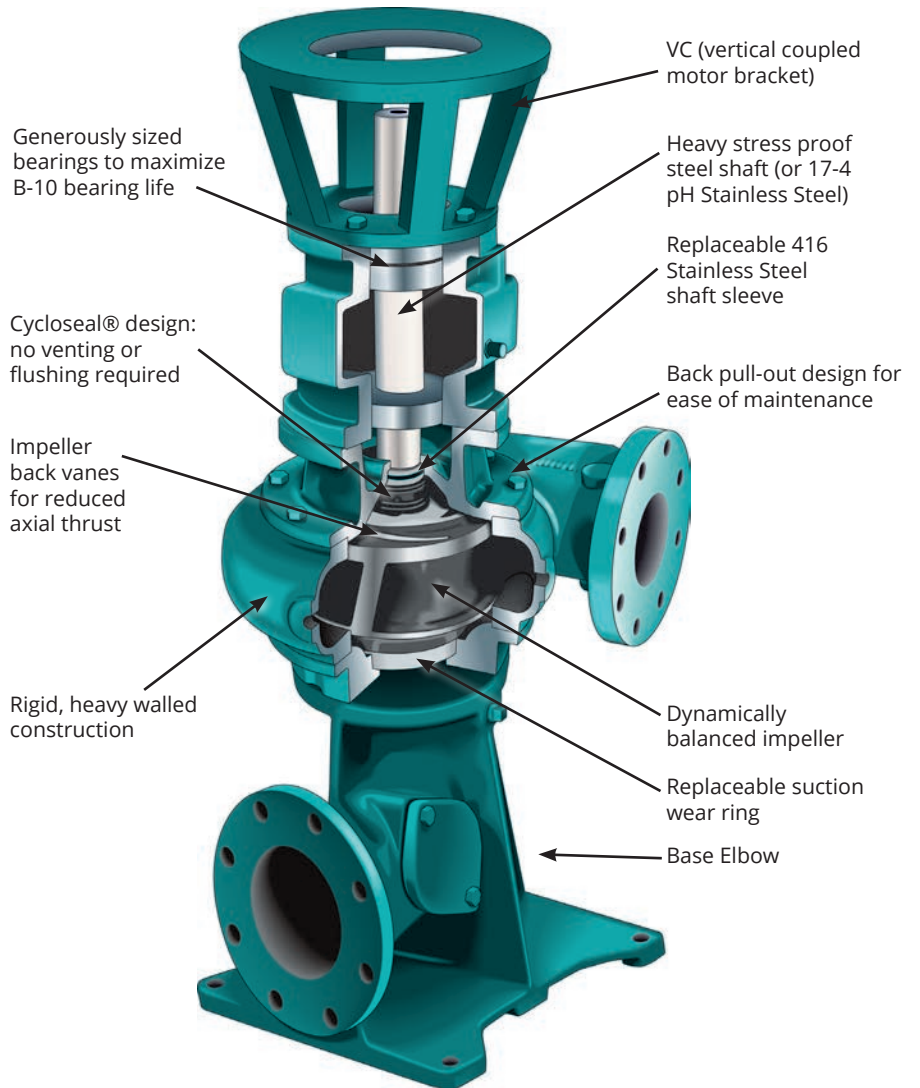

## DOUBLE VOLUTE DESIGN

The double volute system enables Cornell single-stage, end-suction centrifugal pumps to easily perform big volume and high pressure jobs. On single volute pumps, the increasing pressure acts against the impeller area and creates unbalanced radial forces. By contrast, the double volute system effectively balances these forces around the impeller to reduce shaft flexure and fatigue for longer seal life, bearing life and shaft life.

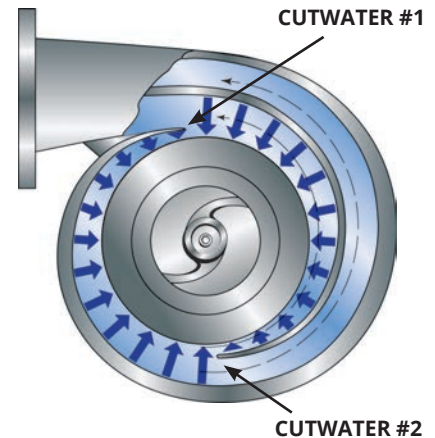

**“VARIOUS DISCHARGE SIZES RANGING FROM 3 TO 30 INCHES, WITH HEADS TO 470 FEET TDH, AND FLOW RATES OF UP TO 38,000 GPM.”**

# SOLIDS HANDLING

## DELTA™ IMPELLER

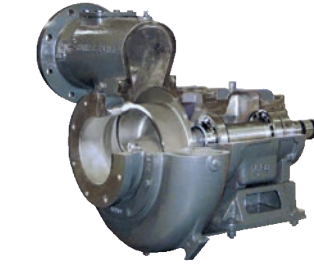
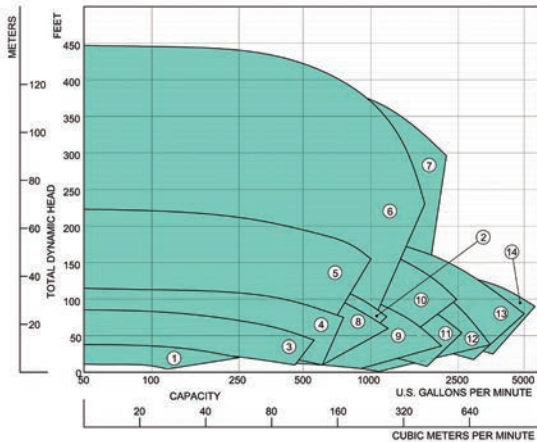

- 1. 3NLA
- 2. 4NLDL
- 3. 4NNDH
- 4. 4NHDH
- 5. 4NHM
- 6. 6NHDH
- 7. 6NHM
- 8. 6NNDH
- 9. 8NNDH
- 10. 10NNDH

## DELTA™ STYLE PUMPS

The trailing edges of Cornell's Delta™ impeller vanes extend continuously across the pump's suction entrance to reduce low pressure areas. Two distinct vortices are created which pass solids through the impeller. The absence of sharp impeller edges prevents hang-up of stringy materials. Many of our enclosed impeller type pumps can be retrofitted with Delta™ style impellers. Delta™ pumps are available in 3 x 3", 4 x 4", 6 x 6", 8 x 8" and 10 x 10" sizes. Capacities range from 50 to 5,000 GPM and heads range from 10 to 450 feet.

## CHOPPER IMPELLER

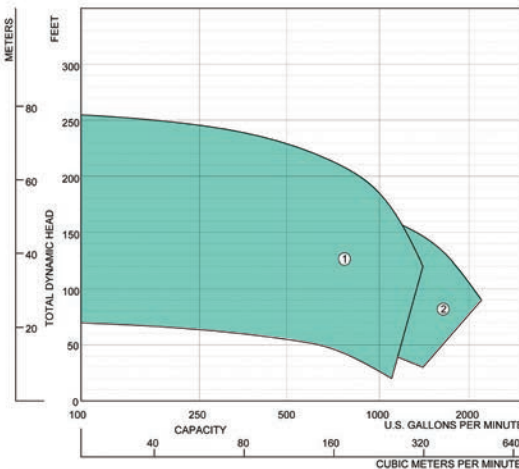

- 1. 4NC
- 2. 6NC

## CHOPPER PUMPS

Cornell Chopper pumps, constructed of ductile iron with replaceable cutter bars of heat treated T1 tool steel are ideally suited for chopping solids. Back to back angular contact ball thrust bearings and single ball radial bearings make for smooth operation. TDH ranges from 5-250 feet with flows to 2,400 GPM.

## ENCLOSED IMPELLER PUMP CURVES

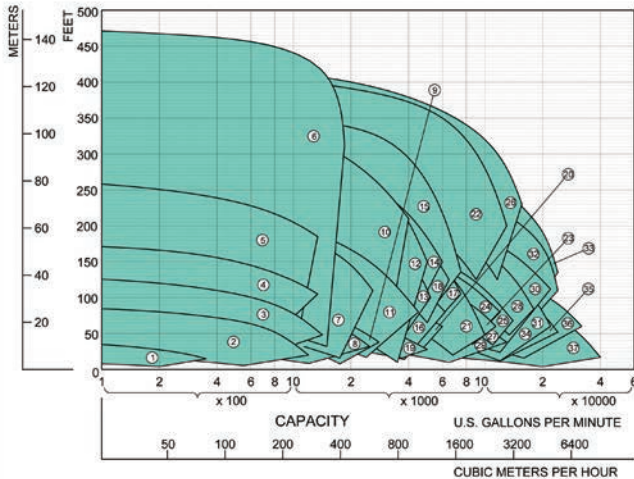

- 1. 3NLT
- 2. 4NNTL
- 3. 4NNT
- 4. 4NHTA
- 5. 4414T
- 6. 4NHTB
- 7. 6NHTA
- 8. 6NNT
- 9. 6NHT/TH
- 10. 6NHTB
- 11. 8NNT
- 12. 8NHTA
- 13. 8NHHT
- 14. 8NHTR
- 15. 8NHGA
- 16. 10NHTB
- 17. 10NHTBH
- 18. 10NHTA
- 19. 12NHTL
- 20. 12NHTM
- 21. 12NNF
- 22. 12NHG28
- 23. 14NHG
- 24. 14NHGA
- 25. 14NHGH
- 26. 14NHG28
- 27. 16NHGH
- 28. 16NHG22
- 29. 16NHG32
- 30. 18NHG
- 31. 18NHFL
- 32. 18NHF34
- 33. 18NHG34
- 34. 20NHFL
- 35. 20NHF
- 36. 24NNG
- 37. 30NNT

## IMMERSIBLE PUMPS

The basic design of the immersible pump/motor is a premium efficient, inverter duty, P-Base or C-Face, totally enclosed, blower cooled motor. The design prevents water infiltration along the shaft into the motor by utilizing a triple redundant sealing system, including a patented Hydroseal design. The immersible motor can withstand up to 30 feet of submergence depth for a 2 week period.



SCAN THIS QR CODE FOR MORE INFO ON SOLIDS HANDLING

# WATER BOOSTER

## CLEAR LIQUID PUMPS

Cornell Clear Liquid pumps are used for commercial and residential irrigation, golf course and lawn maintenance, aqua culture, fountains, breweries, laundries, cooling towers, fire fighting, reverse osmosis feed, and potable water booster systems.

The W, Y, R and H series pumps are available in a wide range of materials with discharge sizes ranging from 1 to 10 inches, heads to 450 feet TDH, and flow rates up to 7,000 GPM.

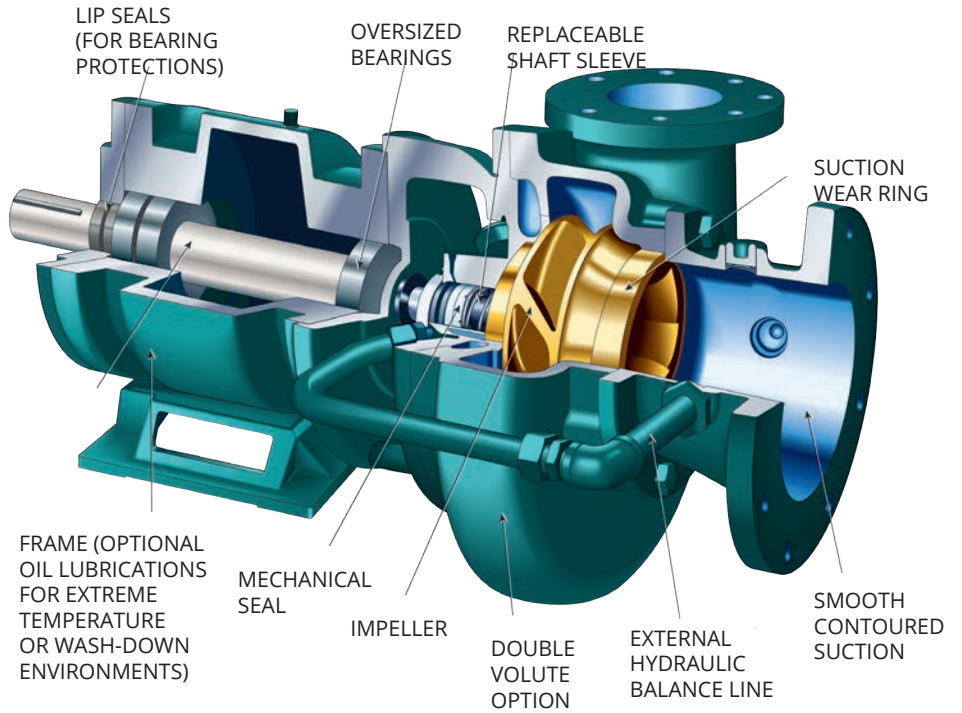

## MATERIALS OF CONSTRUCTION

All Cornell clear liquid pumps are constructed with top quality materials. Cornell water pumps are cast iron, bronze fitted or all iron construction. Available in NSF-61 / ANSI 372-compliant materials for potable water use. Optional materials are available for abrasive or caustic applications. Standard features include balanced impellers, heavy-duty shafts, replaceable shaft sleeves, and replaceable wear rings.

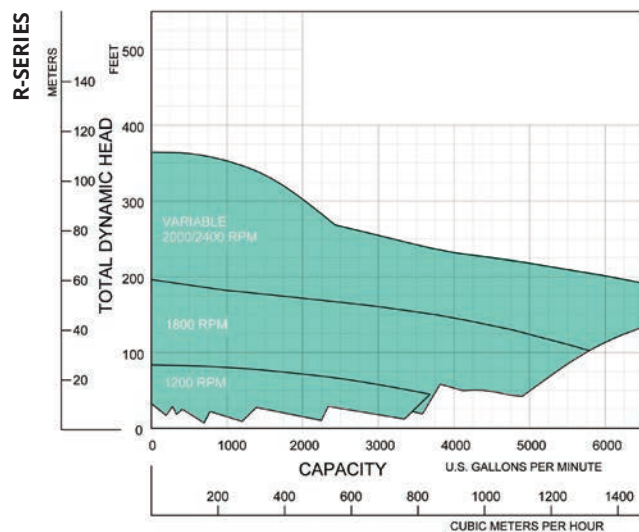
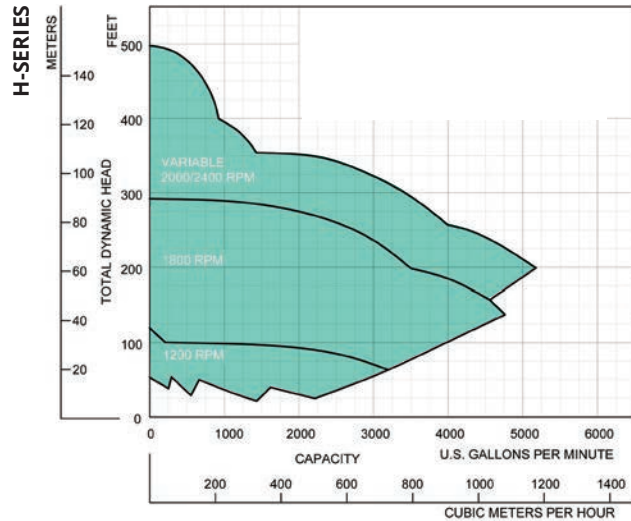

# SUBMERSIBLES

Cornell uses the same high efficiency pump-ends for our submersibles that have been proven time and again in standard municipal applications. Coupled with the highest quality motors, Cornell's submersible product line provides the best possible value.

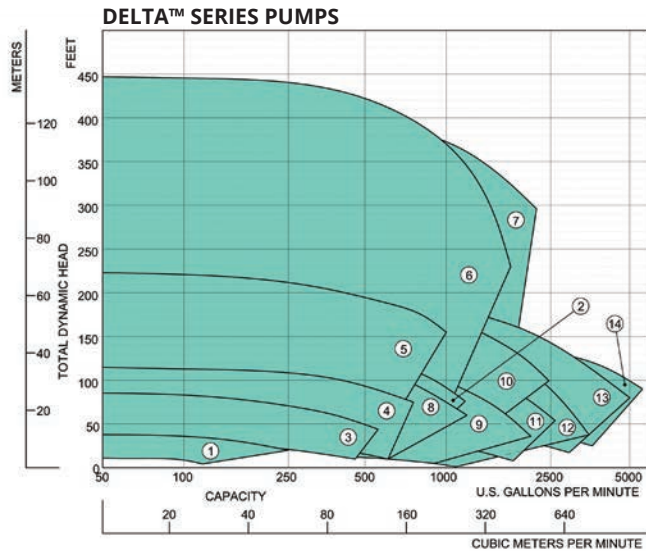

MODEL	5. 4NHDH	10. 6NHM
1. 3NLA	6. 4NHM	11. 6NNDH
2. 3NLHM	7. 4NHM17	12. 8NNDH
3. 4NLDL	8. 4NLHM	13. 10NNDH
4. 4NNDH	9. 6NHDH	14. 10NHM

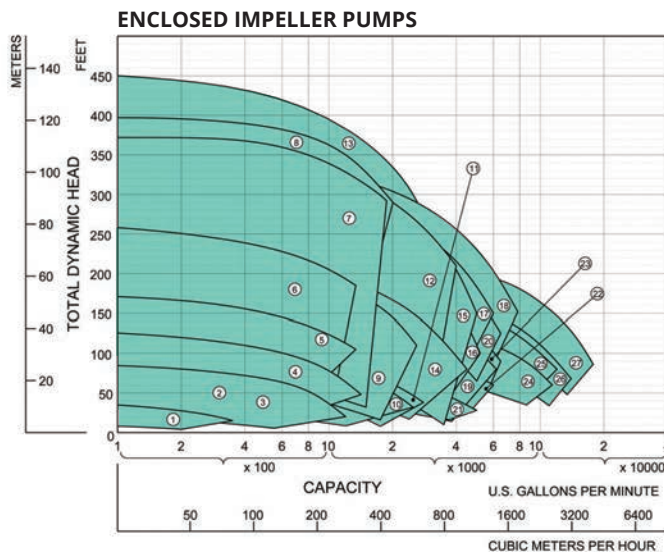

MODEL	7. 4NHTB	14. 8NNT	21. 12NHTL
1. 3NLT	8. 4514T	15. 8NHTA	22. 12NHTM
2. 3NNTL	9. 6NHTA	16. 8NHHT	23. 12NNT
3. 4NNTL	10. 6NNT	17. 8NHTR	24. 14NHG
4. 4NNT	11. 6NHT/TH	18. 10NNT	25. 14NHGA
5. 4NHTA	12. 6NHTB	19. 10NHTB	26. 16NHGH
6. 4414T	13. 6NHTB19	20. 10NHTA	27. 16NHG22

## SUB ACCESSORIES

**HEAVY DUTY AUTO-COUPLING ASSEMBLY** - Discharge elbow with lift out sealing flange assemblies allow for pump service without the need to disconnect plumbing. Available for submersible pumps over the weight limit of STANDARD DUTY auto-couplings or for larger installations requiring a HEAVY DUTY base.

- Ductile iron construction
- Guide rail supports designed to accept standard pipe rails
- O-ring and rubber face sealing ring
- Non-Sparking Design available for certain sizes (contact factory)

Cornell offers different impeller designs for liquid wastewater applications. Cornell's delta style impellers shown on the right below is excellent for handling debris, rags and extremely heavy sludge where there are low to medium head requirements. The two- and three-port enclosed impellers shown on the bottom left are designed to handle large solids and maintain excellent efficiencies.



Enclosed Impeller for high efficiency, 3" solids diameter or larger



Delta™ Style Impeller for Rags, Stringy Material and other severe applications

**"CAPACITIES FROM 80 GPM TO 15,000 GPM AND HEADS FROM 10 FEET TO 400 FEET GIVE CORNELL A CLEAR PERFORMANCE ADVANTAGE."**

# HYDRO-TURBINE

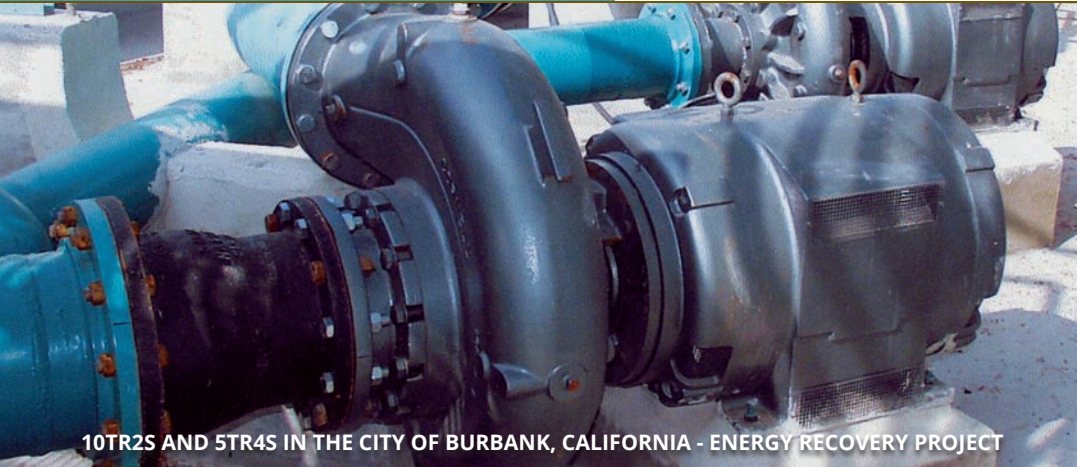

10TR2S AND 5TR4S IN THE CITY OF BURBANK, CALIFORNIA - ENERGY RECOVERY PROJECT

## STANDARD TURBINE CONSTRUCTION:

- Cast Iron, Bronze fittings - optional, Ductile Iron, Steel, Bronze, Stainless Steel.
- Mechanical shaft seal is standard, packing is optional.
- Standard ODP generator - optional TEFC.
- Hydro blue, double applied paint.

## PUMP STATION BYPASS

Cornell Redi-prime® pumps are designed with the suction larger than the discharge. This provides more flow due to reduced friction losses. Cornell's priming system was specifically designed with the environment in mind. By using a positive sealing float box and a diaphragm vacuum pump, there is absolutely no water carry over to contaminate the environment. Suction lifts of 28 feet and heads of up to 470 feet are possible depending on suction losses and operating points on the pump curve.

## REDI-PRIME® SYSTEM

The Redi-prime® system includes a vacuum assisted diaphragm pump, Cycloseal® and Run-Dry™ features. It is a compact, fully automatic, self-priming system, and delivers high hydraulic efficiencies.

## HYDRAULIC ENERGY

Industrial plants, municipalities, HVAC installations, and farms are tapping potential hydraulic energy sources to produce electric power as a revenue source or as a means to reduce overall energy demands. Cornell turbines can handle heads up to 600 feet and flows up to 18 cubic feet per second.

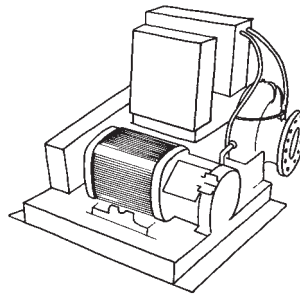

Synchronous generator for stand-alone applications with hydraulic-electric load controller, belt (or direct) drive to turbine, all base assembled.

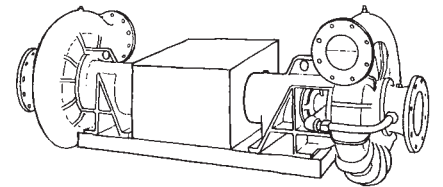

Horizontal frame mounted turbine, direct drive to an energy requiring device. (Turbine driving a pump is shown. A generator may be substituted for the pump.)

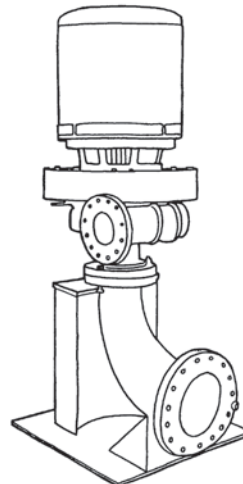

Vertical mount, close coupled turbine with optional integral flywheel\* and base elbow. (Also available without flywheel)

\*Flywheels are used to prevent excessive surge pressures and to give more stable speed control

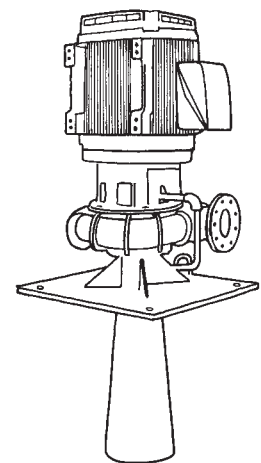

For added space saving or simplicity of manifolding, close coupled, vertical mount with custom draft tub (available less draft tub for discharge manifold mounting).

# CUTTER SOLUTIONS

Dealing with ragging and plugging— six billion flushable toilet wipes, plus over one billion floor and counter cleaning wipes mingle with countless paper towels, baby wipes, feminine hygiene products, grease and other coagulants in sewers worldwide EVERY YEAR!

Cornell's **Waste Warrior™** addresses the problem.

## AUGER CUTTER

The features scythe-like edges from the impeller eye, sweeping all the area where the suction pipe meets the volute.

- Handles most aggressive and troublesome clogs and ragging
- Excellent energy consumption
- Hardened cutter material
- Insignificant flow restrictions
- Does not change external pump dimensions
- Retrofittable



### WATCH A VIDEO

Use your smart phones QR reader to see a short video about the auger cutter solution for the SW Washington water district, or visit our website at <http://www.cornellpump.com/support/videos.html>



## HOW ARE CUTTERS AND CHOPPERS DIFFERENT?

Cornell also makes a chopper pump series in addition to the cutter pumps. While choppers can dice up even more aggressive clogs than cutters, they sacrifice flow, efficiency and head to operate.

### USE A CUTTER FOR:

- ✓ Clogs and ragging
- ✓ To save energy costs
- ✓ When you need a wide range of heads and flows
- ✓ If you want to retrofit
- ✓ If you are passing along to a main trunk or pipeline

### USE A CHOPPER FOR:

- ✓ Severe plugging
- ✓ When energy efficiency is a minimal concern
- ✓ If the application will work with a narrow flow range
- ✓ If you don't need to work with existing equipment
- ✓ If you are unconcerned that material will plug further in process

## CYCLOSEAL

Cornell's Cycloseal design has proven itself in the toughest applications from manure slurry to starch recovery to sewer bypass and mining applications - in some cases more than tripling the normally expected mechanical seal life.

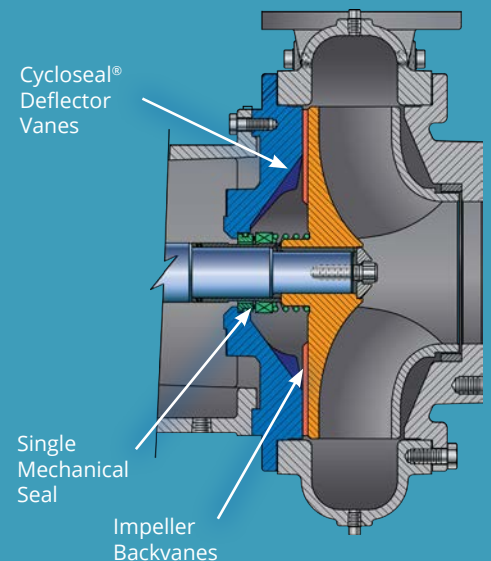

**System Savings:** The Cycloseal® system requires no external water flush, filters, grease cups, piping or instrumentation normally associated with packing or double mechanical seals.

**Maintenance Savings:** Longer seal life which translates into less pump down time and lower maintenance costs.



# MARKET AND PRODUCT LINE



AGRICULTURE



FOOD PROCESS



INDUSTRIAL



MINING

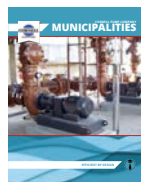

MUNICIPAL



WATER TRANSFER



REFRIGERATION



CONSTRUCTION



SLURRY

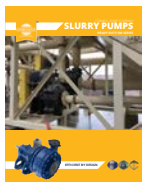

SLURRY SM



MANURE



CUTTERS



SELF PRIMING



HIGH FLOW



MX SERIES



N SERIES



CYCLONE™



EDGE™



HYDRAULIC SUBS



IMMERSIBLE



CD4MCU



RUN-DRY™



PRIMING SYSTEMS



CYCLOSEAL®

Cycloseal® and Redi-Prime® are Registered Trademarks of Cornell Pump Company.

Cornell pumps and products are the subject of one or more of the following U.S. and foreign patents: 3,207,485; 3,282,226; 3,295,456; 3,301,191; 3,630,637; 3,663,117; 3,743,437; 4,335,886; 4,523,900; 5,489,187; 5,591,001; 6,074,554; 6,036,434; 6,079,958; 6,309,169; 2,320,742; 96/8140; 319,837; 918,534; 1,224,969; 2,232,735; 701,979 and are the subject of pending U.S. and foreign patent applications.

**CORNELLPUMP.COM**  
©2019 CORNELL PUMP COMPANY



Cornell Pump Company  
Clackamas, Oregon, USA  
P: +1 (503) 653-0330  
F: +1 (503) 653-0338

AUTHORIZED CORNELL PUMP DISTRIBUTOR